

YAMAHA AX-392

Natural Sound Stereo Integrated Amplifier

Préampli/ampli de puissance stéréo de la série "Natural Sound"

Natural Sound Stereo-Verstärker

Natural Sound Integrerad Stereo Förstärkare

Amplificatore integrato stereo a Suono Naturale

Amplificador integrado estéreo de Sonido Natural

Natural Sound Geïntegreerde Stereo Versterker

OWNER'S MANUAL
MODE D'EMPLOI
BEDIENUNGSANLEITUNG
BRUKSANVISNING
MANUALE DI ISTRUZIONI
MANUAL DE INSTRUCCIONES
GEBRUIKSAANWIJZING

SUPPLIED ACCESSORIES
ACCESSOIRES FOURNIS
MITGELIEFERTES ZUBEHÖR
MEDFÖLJANDE TILLBEHÖR
ACCESSORI IN DOTAZIONE
ACCESORIOS INCLUIDOS
BIJGELEVERDE ACCESSOIRES

- After unpacking, check that the following parts are contained.
- Après le déballage, vérifier que les pièces suivantes sont incluses.
- Nach dem Auspacken überprüfen, ob die folgenden Teile vorhanden sind.
- Kontrollera efter det apparaten packats upp att följande delar finns med.
- Verificare che tutte le parti seguenti siano contenute nell'imballaggio dell'apparecchio.
- Desembale el aparato y verificar que los siguientes accesorios están en la caja.
- Controleer na het uitpakken of de volgende onderdelen voorhanden zijn.

- Remote Control Transmitter
- Emetteur de télécommande
- Fernbedienung
- Fjärrkontroll
- Telecomando
- Transmisor del control remoto
- Afstandbediening

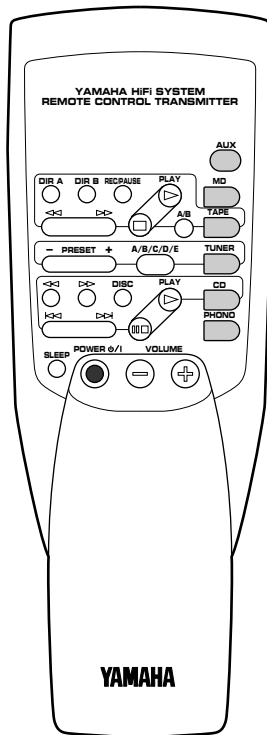

- Batteries (size AA, R6, UM-3)
- Piles (taille AA, R6, UM-3)
- Batterien (Größe AA, R6, UM-3)
- Batterier (storlek AA, R6, UM-3)
- Batterie (dimensioni AA, R6, UM-3)
- Pilas (tamaño AA, R6, UM-3)
- Batterijen (maat AA, R6, UM-3)

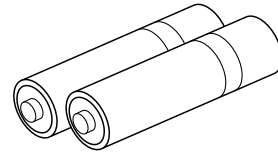

Thank you for selecting this YAMAHA stereo amplifier.

FEATURES

- **60W + 60W (8Ω) RMS Output Power, 0.04% THD, 20–20,000 Hz**
- **High Dynamic Power, Low Impedance Drive Capability**
- **Continuously Variable LOUDNESS Control**
- **CD DIRECT AMP Switch to Reproduce the Purest CD Sound**
- **Remote Control Capability**

CONTENTS

SUPPLIED ACCESSORIES	2
FEATURES	3
CAUTION	4
NOTES ABOUT THE REMOTE CONTROL TRANSMITTER	5
CONNECTIONS	6
CONTROLS AND THEIR FUNCTIONS	8
OPERATIONS	11
TROUBLESHOOTING	14
SPECIFICATIONS	15

CAUTION: READ THIS BEFORE OPERATING YOUR UNIT.

1. To assure the finest performance, please read this manual carefully. Keep it in a safe place for future reference.
2. Install this unit in a cool, dry, clean place – away from windows, heat sources, sources of excessive vibration, dust, moisture and cold. Avoid sources of humming (transformers, motors). To prevent fire or electrical shock, do not expose the unit to rain or water.
3. Never open the cabinet. If something drops into the set, contact your dealer.
4. Do not use force on switches, controls or connection wires. When moving the unit, first disconnect the power plug and the wires connected to other equipment. Never pull the wires themselves.
5. The openings on the cabinet assure proper ventilation of the unit. If these openings are obstructed, the temperature inside the cabinet will rise rapidly. Therefore, avoid placing objects against these openings, and install the unit in well-ventilated condition. Be sure to allow a space of at least 10 cm behind, 10 cm on the both sides and 20 cm above the top panel of the unit. Otherwise it may not only damage the unit, but also cause fire.
6. Always set the VOLUME control to “- ∞” before starting the audio source play: increase the volume gradually to an appropriate level after the play has been started.
7. Do not attempt to clean the unit with chemical solvents; this might damage the finish. Use a clean, dry cloth.
8. Be sure to read the “TROUBLESHOOTING” section regarding common operating errors before concluding that the unit is faulty.
9. **When not planning to use this unit for long periods of time (ie., vacation, etc.), disconnect the AC power plug from the wall outlet.**
10. To prevent lightning damage, disconnect the AC power plug and antenna cable when there is an electrical storm.
11. Grounding or polarization – Precautions should be taken so that the grounding or polarization of an appliance is not defeated.
12. Do not connect audio equipment to the AC outlet on the rear panel if the equipment requires more power than the outlet is rated to provide.
13. **Voltage Selector (China and General Models only)**
The voltage selector on the rear panel of this unit must be set for your local main voltage **BEFORE** plugging into the AC main supply.
Voltages are 110/120/220/240 V AC, 50/60 Hz.

IMPORTANT

Please record the serial number of this unit in the space below.

Model:

Serial No.:

The serial number is located on the rear of the unit. Retain this Owner's Manual in a safe place for future reference.

WARNING

TO REDUCE THE RISK OF FIRE OR ELECTRIC SHOCK, DO NOT EXPOSE THIS UNIT TO RAIN OR MOISTURE.

This unit is not disconnected from the AC power source as long as it is connected to the wall outlet, even if this unit itself is turned off. This state is called the standby mode. In this state, this unit is designed to consume a very small quantity of power.

For U.K. customers

If the socket outlets in the home are not suitable for the plug supplied with this appliance, it should be cut off and an appropriate 3 pin plug fitted. For details, refer to the instructions described below.

Note: The plug severed from the mains lead must be destroyed, as a plug with bared flexible cord is hazardous if engaged in a live socket outlet.

SPECIAL INSTRUCTIONS FOR U.K. MODEL

IMPORTANT:

THE WIRES IN MAINS LEAD ARE COLOURED IN ACCORDANCE WITH THE FOLLOWING CODE:

Blue: NEUTRAL

Brown: LIVE

As the colours of the wires in the mains lead of this apparatus may not correspond with the coloured markings identifying the terminals in your plug, proceed as follows: The wire which is coloured BLUE must be connected to the terminal which is marked with the letter N or coloured BLACK. The wire which is coloured BROWN must be connected to the terminal which is marked with the letter L or coloured RED. Making sure that neither core is connected to the earth terminal of the three pin plug.

WARNING

Do not change the IMPEDANCE SELECTOR switch setting while the power to this unit is on, otherwise this unit may be damaged.

IF THIS UNIT FAILS TO TURN ON WHEN THE STANDBY/ON SWITCH IS PRESSED;

The **IMPEDANCE SELECTOR** switch may not be set to either end closely. If so, set the switch to either end closely.

IMPEDANCE SELECTOR

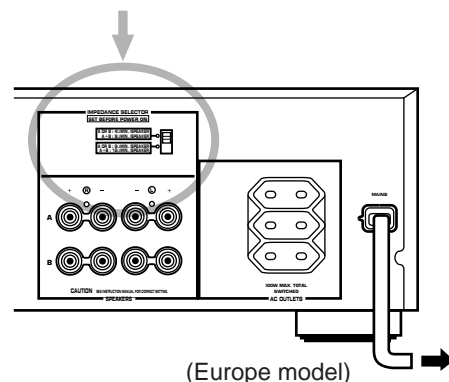

NOTES ABOUT THE REMOTE CONTROL TRANSMITTER

Battery installation

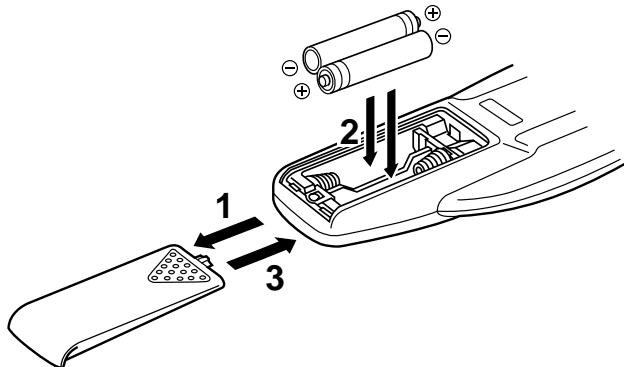

Battery replacement

If you find that the remote control transmitter must be used closer to the main unit, the batteries are weak. Replace both batteries with new ones.

Notes

- Use only AA, R6, UM-3 batteries for replacement.
- Be sure the polarities are correct. (See the illustration inside the battery compartment.)
- Remove the batteries if the remote control transmitter will not be used for an extended period of time.
- If batteries leak, dispose of them immediately. Avoid touching the leaked material or letting it come in contact with clothing, etc. Clean the battery compartment thoroughly before installing new batteries.

Remote control transmitter operation range

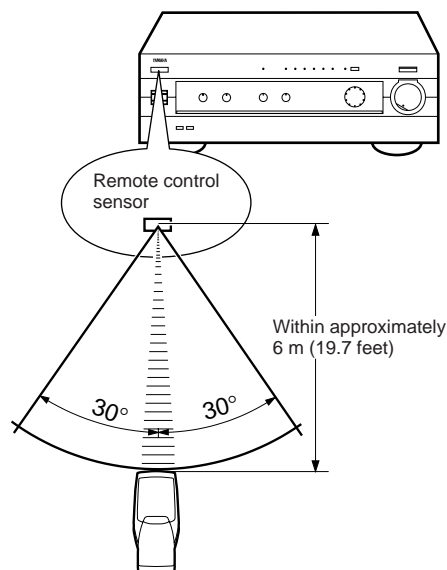

Notes

- There should be no large obstacles between the remote control transmitter and the main unit.
- If the remote control sensor is directly illuminated by strong lighting (especially an inverter type of fluorescent lamp etc.), it might cause the remote control transmitter not to work correctly. In this case, reposition the main unit to avoid direct lighting.

CONNECTIONS

Never plug in this unit and other components until all connections are completed.

- When making connections between this unit and other components, be sure all connections are made correctly, that is to say L (left) to L, R (right) to R, “+” to “+” and “-” to “-”. Also, refer to the owner’s manual for each component to be connected to this unit.
- If you have YAMAHA components numbered as 1, 2, 3, 4, etc. on the rear panel, connections can be made easily by only connecting the output (or input) terminals of each component to the same-numbered terminals of this unit.

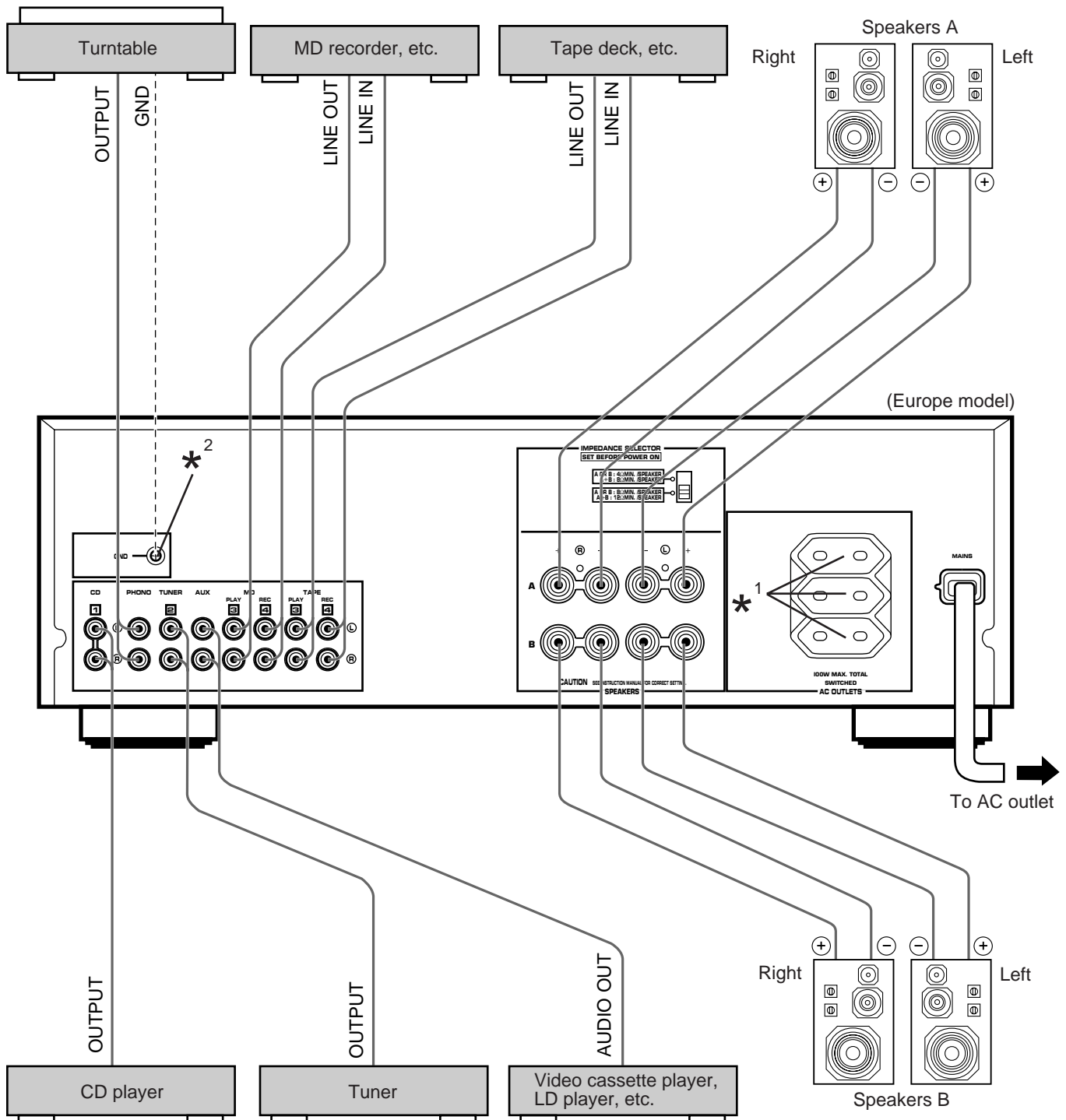

*¹, *² : Refer to “ABOUT THE ACCESSORY TERMINALS” on page 7.

CONNECTING SPEAKERS

Connect the **SPEAKERS** terminals to your speakers with wire of the proper gauge, cut as short as possible. If the connections are faulty, no sound will be heard from the speakers. Make sure that the polarity of the speaker wires is correct, that is, + and – markings are observed. If these wires are reversed, the sound will be unnatural and lack bass. **Do not let the bare speaker wires touch each other or the metal parts of this unit as this could damage this unit and/or speakers.**

How to Connect:

Red: positive (+)
Black: negative (–)

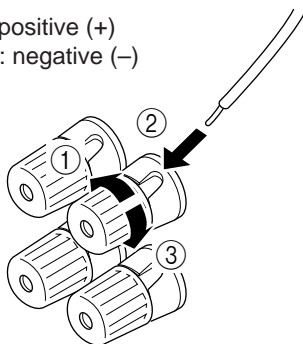

- ① Unscrew the knob.
- ② Insert the bare wire.
[Remove approx. 5mm (1/4") insulation from the speaker wires.]
- ③ Tighten the knob and secure the wire.

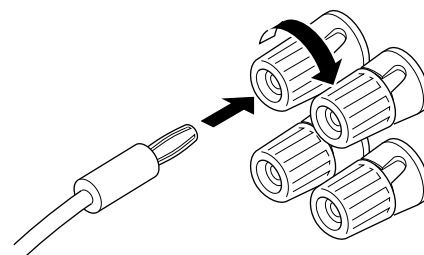

- One or two speaker systems can be connected to this unit. If you connect only one speaker system, connect it to either the **SPEAKERS A** or **B** terminals.
- Use speakers with the specified impedance shown on the rear of this unit.
- **<China and General models only>**
Banana Plug connections are also possible. Simply insert the Banana Plug connector into the corresponding terminal.

IMPEDANCE SELECTOR switch

Be sure to switch this only when the power to this unit is not on.
Select the position whose requirements your speaker system meets.

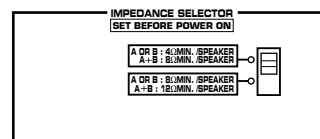

WARNING

Do not change the IMPEDANCE SELECTOR switch setting while the power to this unit is on, otherwise this unit may be damaged.

IF THIS UNIT FAILS TO TURN ON WHEN THE STANDBY/ON SWITCH IS PRESSED;

The **IMPEDANCE SELECTOR** switch may not be set to either end closely. If so, set the switch to either end closely.



(Upper position)

If you use one pair of speakers, the impedance of each speaker must be 4Ω or higher.
If you use two pairs of speakers, the impedance of each speaker must be 8Ω or higher.



(Lower position)

If you use one pair of speakers, the impedance of each speaker must be 6Ω or higher.
If you use two pairs of speakers, the impedance of each speaker must be 12Ω or higher.

ABOUT THE ACCESSORY TERMINALS

AC OUTLET(S) (SWITCHED) *¹

(Europe, China and General models)

..... 3 SWITCHED OUTLETS
(U.K. model) 1 SWITCHED OUTLET

Use these to connect the power cords from your components to this unit.

The power to the **SWITCHED** outlets is controlled by this unit's **STANDBY/ON** switch or the provided remote control transmitter's **POWER** key. These outlets will supply power to any component whenever this unit is turned on.

The maximum power (total power consumption of components) that can be connected to the **SWITCHED AC OUTLET(S)** is 100 watts.

GND terminal (For turntable use) *²

Connecting the ground wire of the turntable to this terminal will normally minimize hum, but in some cases better results may be obtained with the ground wire disconnected.

CONTROLS AND THEIR FUNCTIONS

FRONT PANEL

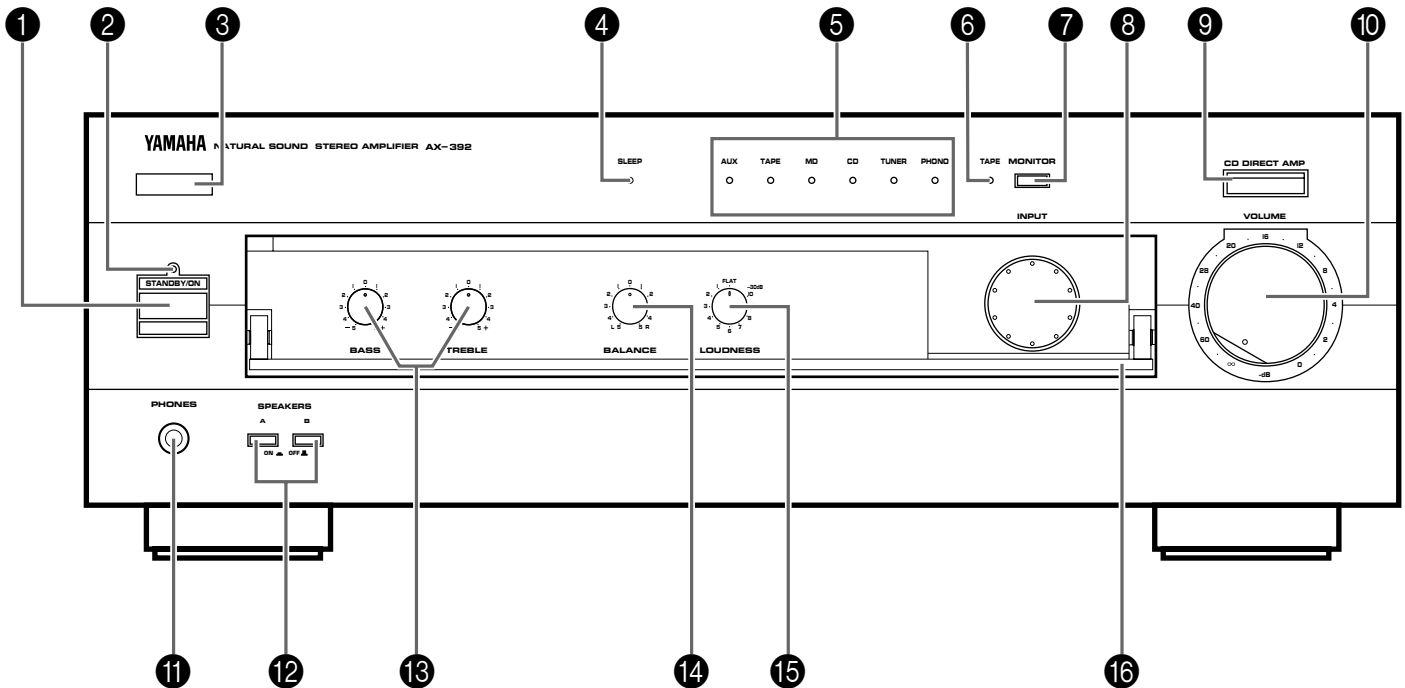

1 STANDBY/ON switch

Press this switch to turn the power to this unit on. Press it again to turn this unit into the standby mode.

Standby mode

In this state, this unit consumes a very small quantity of power to receive infrared-signals from the remote control transmitter.

2 Power indicator

Lights up while the power to this unit is on.

3 Remote control sensor

Receives signals from the remote control transmitter.

4 SLEEP indicator

Lights up while the built-in SLEEP timer is functioning.

5 Input source indicators

The indicator for the source selected by the **INPUT** selector lights up.

6 TAPE MONITOR indicator

Lights up while the **TAPE MONITOR** switch is on.

* When the tape deck (**TAPE**) is selected as the input source, this indicator will not light up even if the **TAPE MONITOR** switch is on.

7 TAPE MONITOR switch

When the tape deck connected to the **TAPE** terminals on the rear of this unit is used for recording, you can monitor the sounds being recorded by pressing **TAPE MONITOR** so that **TAPE MONITOR** indicator lights up.

8 INPUT selector

When turned, selects a program source to listen to. The input source indicator for the currently selected source lights up.

9 CD DIRECT AMP switch

Press this switch inward to listen to a CD source in the purest sound. (Refer to page 13 for details.)

10 VOLUME control

Used to raise or lower the volume level.

11 PHONES jack

When you listen with headphones, connect the headphones to the **PHONES** jack.

When listening with headphones privately, set both the **SPEAKERS A** and **B** switches to the **OFF** position.

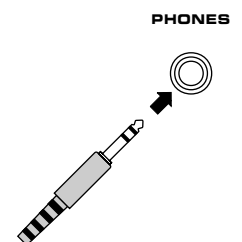

12 SPEAKERS switches

Set the switch **A** or **B** (or both **A** and **B**) for the speaker system (connected to this unit) you will use to the **ON** position. Set the switch for the speaker system you will not use to the **OFF** position.

13 Tone controls**BASS**

Used to increase or decrease the low frequency response. The 0 position produces flat response.

TREBLE

Used to increase or decrease the high frequency response. The 0 position produces flat response.

14 BALANCE control

Adjusts the balance of the output volume to the left and right speakers to compensate for sound imbalance caused by speaker location or listening room conditions.

15 Continuously variable LOUDNESS control

Used to compensate for the human ears' loss of sensitivity to high and low-frequency ranges at low volume.

16 Control door

See below for how to open and close the control door.

Open/close the control door

When it is not necessary to operate controls inside the control door, close the door.

To open the door

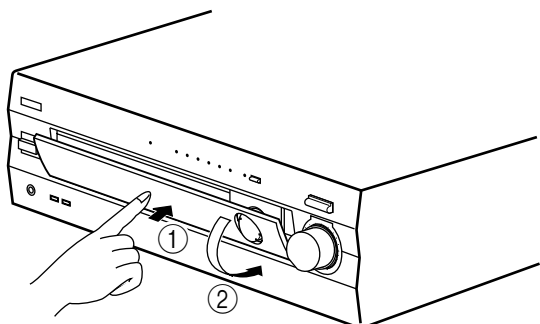

To close the door

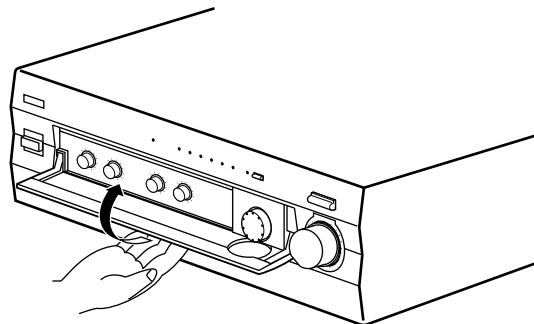

REMOTE CONTROL TRANSMITTER

The remote control transmitter provided with this unit is designed to control all the most commonly used functions of this unit. If the CD player, tuner, tape deck, etc. connected to this unit are YAMAHA components designed for remote control compatibility, then this remote control transmitter will also control various functions of each component.

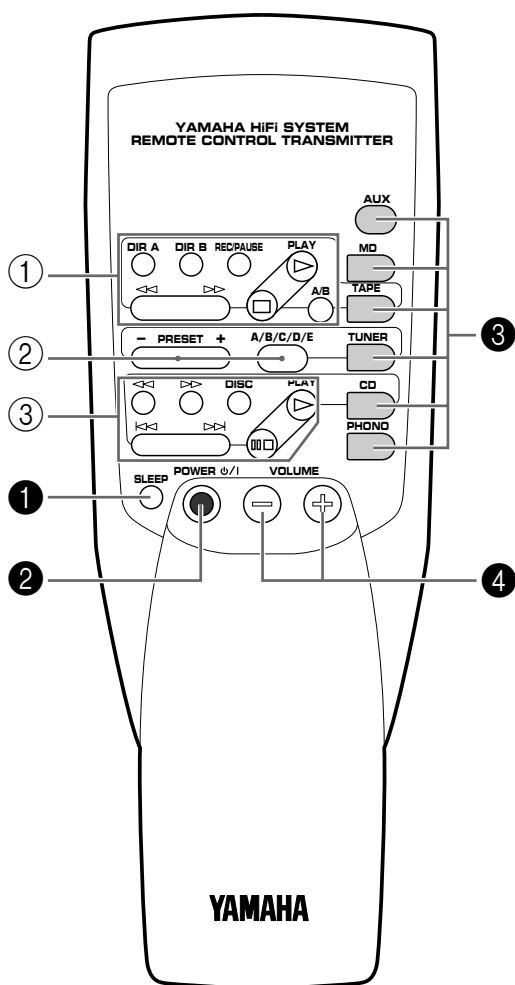

For Control of This Unit

① SLEEP timer key

This unit is automatically turned into the standby mode one hour after this key is pressed (so that SLEEP indicator lights up).

② POWER key

Turns the power to this unit on and turns this unit into the standby mode alternately.

③ Input selector keys

Select input source.

④ VOLUME +/- keys

Turn the volume level up/down.

For Other Component Control

Identify the remote control transmitter keys with your component's keys. If these keys are identical, their functions will be the same. For each key function, refer to the corresponding instruction in your component's manual.

① Tape deck keys

Control tape deck.

- * **DIR A, B** and **A/B** are applicable only to double cassette tape deck.
- * For a single cassette deck with automatic reverse function, pressing **DIR A** will reverse the direction of tape running.

② Tuner keys

Control tuner.

+: Selects higher preset station number.

-: Selects lower preset station number.

A/B/C/D/E: Selects the group (A – E) of preset station numbers.

③ CD player keys

Control compact disc player.

- * **DISC** is applicable only to compact disc changer.

OPERATIONS

TO PLAY A SOURCE

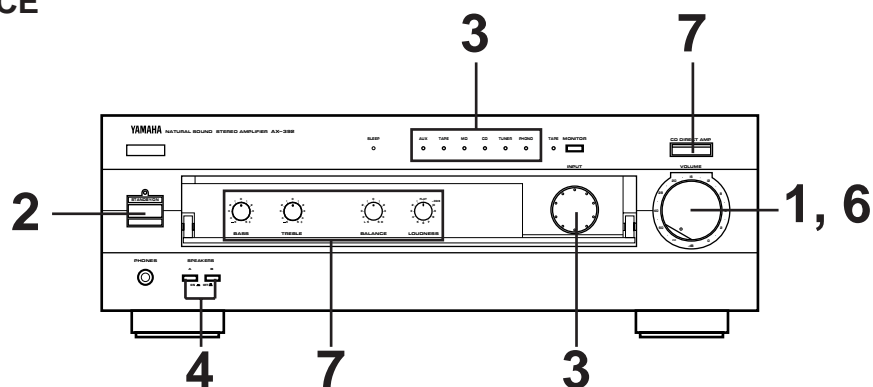

1

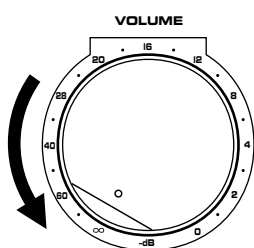

Set to the "∞" position.

2

Turn the power on.

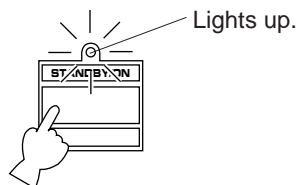

3

Select a desired input source.

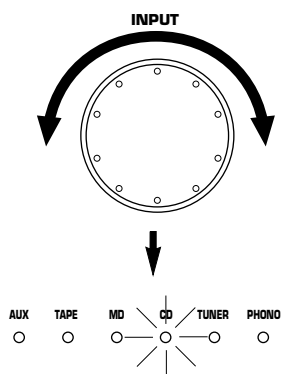

The indicator for the selected source lights up.

4

Select the speakers to be used.

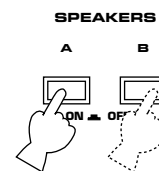

* If you use two speaker systems, press both the A and B switches.

5

Play the source.

6

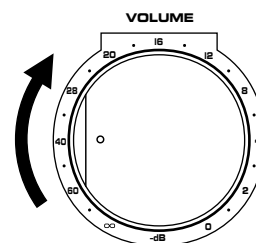

Adjust to the desired output level.

7

If desired, adjust the **BASS**, **TREBLE**, **BALANCE** and **LOUDNESS** controls or turn on the **CD DIRECT AMP** switch. (Refer to page 13).

Note

If the **TAPE MONITOR** indicator is illuminated when you listen to a source, press the **TAPE MONITOR** switch to turn off the **TAPE MONITOR** indicator.

When you finish using this unit

Press the **STANDBY/ON** switch again to turn this unit into the standby mode.

Standby mode

In this state, this unit consumes a very small quantity of power to receive infrared-signals from the remote control transmitter.

TO RECORD A SOURCE TO TAPE (OR MD)

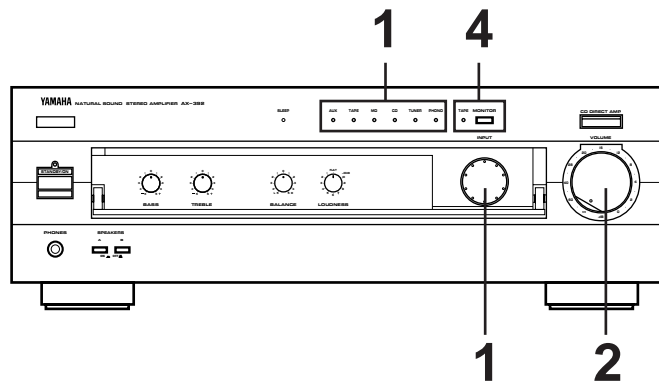

- 1** Select the source you want to record.

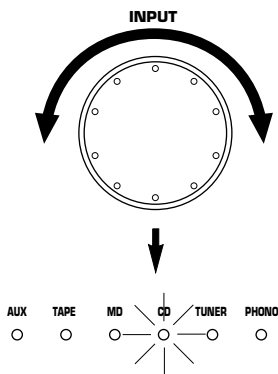

- 2** Play the source and then turn the **VOLUME** control up to confirm the input source.

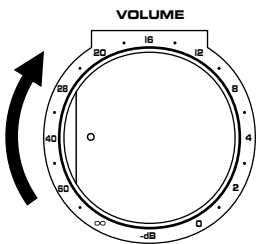

- 3** Begin recording on the tape deck (or MD recorder etc.) connected to this unit.

- 4** If the tape deck connected to the TAPE terminals on the rear of this unit is used for recording, you can monitor the sounds being recorded by pressing the **TAPE MONITOR** switch so that the TAPE MONITOR indicator lights up.

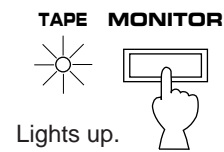

Note
VOLUME, BASS, TREBLE, BALANCE, LOUDNESS controls and **CD DIRECT AMP** switch settings have no effect on the material being recorded.

Adjusting the BALANCE control

Adjust the balance of the output volume to the left and right speakers to compensate for sound imbalance caused from speaker location or listening room conditions.

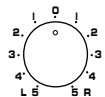

BALANCE

Adjusting the BASS and TREBLE controls

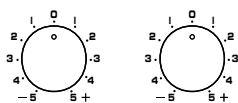

BASS

TREBLE

BASS : Turn this clockwise to increase (or counter-clockwise to decrease) the low frequency response.

TREBLE : Turn this clockwise to increase (or counter-clockwise to decrease) the high frequency response.

Selecting the SPEAKER system

Because one or two speaker systems can be connected to this unit, the **SPEAKERS** switches allow you to select speaker system **A** or **B**, or both at once.

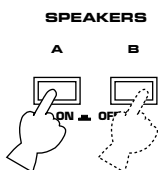

SPEAKERS

A

B

Using the CD DIRECT AMP switch

You can enjoy the purest possible CD sound from your CD player by pressing this switch inward. By doing so, CD's input signals are sent to the built-in special amplifier for CD directly bypassing the **INPUT** selector, the **BASS**, **TREBLE**, **BALANCE** and **LOUDNESS** controls, and then sent to the power amplifier. This signal routing reproduces the purest CD sound eliminating any alterations to the CD signals.

CD DIRECT AMP

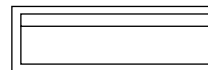

Adjusting the continuously variable LOUDNESS control

This control provides compensation for the human ears' loss of sensitivity to high and low-frequency ranges at low volume. This control is adjustable to retain full tonal range at any volume level.

1

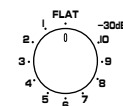

LOUDNESS

Set to the "FLAT" position.

2

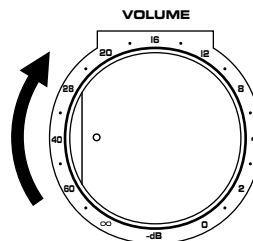

Set to the loudest listening level that you would listen to.

3

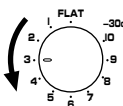

LOUDNESS

Turn until the desired volume is gained.

TROUBLESHOOTING

If the unit fails to operate normally, check the following points to determine whether the fault can be corrected by the simple measures suggested. If it cannot be corrected, or if the fault is not listed in the SYMPTOM column, disconnect the power cord and contact your authorized YAMAHA dealer or service center for help.

SYMPTOM	CAUSE	REMEDY
The unit fails to turn on when the STANDBY/ON switch is pressed, or turns into the standby mode suddenly soon after the power is turned on.	Power cord is not plugged in or is not completely inserted.	Firmly plug in the power cord.
	The IMPEDANCE SELECTOR switch on the rear panel is not set to either end closely.	Set the switch to either end closely.
It happens that this unit does not work normally.	There is an influence of strong external noise (lightning, excessive static electricity, etc.) or a misoperation on this unit while using this unit.	Turn this unit into the standby mode and disconnect the AC power cord from the AC outlet. After about 30 seconds have passed, connect the power and operate this unit again.
No sound.	Incorrect output cord connections.	Connect the cords properly. If the problem persists, the cords may be defective.
	Appropriate input source is not selected.	Select an appropriate input source with the INPUT selector.
	The SPEAKERS switches are not set properly.	Set the SPEAKERS switch which corresponds to the speakers to be used to the ON position.
	Speaker connections are not secure.	Secure the connections.
The sound suddenly goes off.	The protection circuit has been activated because of short circuit etc.	Turn this unit into the standby mode, and then turn this unit on to reset the protection circuit.
	The SLEEP timer has functioned.	Cancel the SLEEP timer function.
Only one side speaker outputs the sound.	Incorrect setting of the BALANCE control.	Adjust it to the appropriate position.
	Incorrect cord connections.	Connect the cords properly. If the problem persists, the cords may be defective.
There is a lack of bass, and no ambience.	The + and – wires are connected in reverse at the amplifier or speakers.	Connect the speaker wires in the correct phase (+ and –).
Sound “hums”.	Incorrect cord connections.	Firmly connect the audio plugs. If the problem persists, the cords may be defective.
	No connection from the turntable to the GND terminal.	Make the GND connection between the turntable and this unit.
The volume level is low while playing a record.	The record is being played on a turntable with an MC cartridge.	The player should be connected to the unit through the MC head amplifier.
The volume level cannot be increased, or sound is distorted.	The component connected to the REC terminals of this unit is turned off.	Turn the power to the component on.
The sound is degraded when listening with the headphones connected to the compact disc player or tape deck that are connected with this unit.	This unit is in the standby mode.	Turn the power to this unit on.
Sound level is low.	The LOUDNESS control is functioning.	Set the LOUDNESS control to the FLAT position.
The input source cannot be changed, though the INPUT selector is turned.	The CD DIRECT AMP switch is ON.	Switch off the CD DIRECT AMP switch.
Using the BASS, TREBLE, BALANCE and LOUDNESS controls does not affect the tone.	The CD DIRECT AMP switch is ON.	The CD DIRECT AMP switch must be switched OFF to use those controls.
The remote control transmitter does not work.	Direct sunlight or lighting (of an inverter type of fluorescent lamp etc.) is striking the remote control sensor of the main unit.	Change position of the main unit.
The distance or range within which the remote control transmitter can be used is short.	The batteries of this remote control transmitter are too weak.	Replace the batteries with new ones.

SPECIFICATIONS

Minimum RMS Output Power per Channel		Signal-to-Noise Ratio (IHF-A Network)	
8 ohms, 20 Hz to 20 kHz, 0.04% THD	60W+60W	PHONO MM (5 mV Input Shorted)	82 dB
6 ohms, 20 Hz to 20 kHz, 0.08% THD	70W+70W	CD/TUNER/AUX/MD/TAPE (Shorted, CD DIRECT AMP: ON)	108 dB
Maximum Output Power (6 ohms, 1 kHz, 10% THD) [China and General models only]	110W	Residual Noise (IHF-A Network)	
Dynamic Power per Channel (by IHF Dynamic Headroom measuring method) 8/6/4/2 ohms	100/120/140/150W	CD DIRECT AMP: ON	35 μ V
DIN Standard Output Power per Channel (4 ohms, 1 kHz, 0.7% THD) [U.K. and Europe models only]	95W	CD DIRECT AMP: OFF	100 μ V
IEC Power (8 ohms, 1 kHz, 0.04% THD) [U.K. and Europe models only]	75W	Channel Separation	
Power Band Width		CD/TUNER/AUX/MD/TAPE (Input 5.1 k-ohms Terminated 1 kHz)	60 dB
8 ohms, 30W, 0.1% THD	10 Hz to 50 kHz	Tone Control Characteristics	
Damping Factor		BASS:	
8 ohms, 20 Hz to 20 kHz	100 or more	Boost/cut	\pm 10 dB (20 Hz)
Input Sensitivity/Impedance		Turnover Frequency	350 Hz
PHONO MM	2.5 mV/47 k-ohms	TREBLE:	
CD/TUNER/AUX/MD/TAPE	150 mV/47 k-ohms	Boost/cut	\pm 10 dB (20 kHz)
Maximum Input Signal (1 kHz, 0.04% THD)		Turnover Frequency	3.5 kHz
PHONO MM	90 mV	Continuously variable LOUDNESS Control (Level related equalization)	
Output Level/Impedance		Attenuation	-30 dB (1 kHz)
PHONO MM to REC OUT	150 mV/1 k-ohms	Power Supply	
Headphone Jack Rated Output/ Impedance		[U.K. and Europe models]	AC 230V, 50 Hz
Output Level (8 ohms, 1 kHz, 0.04% THD)	0.31V	[China and General models]	AC 110/120/220/240V, 60/50 Hz
Impedance	560 ohms	Power Consumption	
Frequency Response (20 Hz to 20 kHz)		[U.K. and Europe models]	150W
CD/TUNER/AUX/MD/TAPE	0 \pm 0.5 dB	(In the standby mode: 1.2W)	
RIAA Equalization Deviation		[China and General models]	150W
PHONO MM	0 \pm 0.5 dB	(In the standby mode: 1.8W)	
Total Harmonic Distortion (20 Hz to 20 kHz)		AC Outlets	
PHONO MM to REC OUT (1V)	0.02%	3 SWITCHED OUTLETS	
CD/TUNER/AUX/MD/TAPE to SP OUT (30W/8 ohms)	0.02%	[Europe, China and General models]	100W max. total
		1 SWITCHED OUTLET	
		[U.K. model]	100W max. total
		Dimensions (W x H x D)	435 x 151 x 309.3 mm (17-1/8" x 5-15/16" x 12-3/16")
		Weight	7.6 kg (16 lbs. 12 oz.)
		Accessories	Remote control transmitter Batteries

Specifications subject to change without notice.

YAMAHA

YAMAHA ELECTRONICS CORPORATION, USA 6660 ORANGETHORPE AVE., BUENA PARK, CALIF. 90620, U.S.A.
YAMAHA CANADA MUSIC LTD. 135 MILNER AVE., SCARBOROUGH, ONTARIO M1S 3R1, CANADA
YAMAHA ELECTRONIK EUROPA G.m.b.H. SIEMENSSTR. 22-34, 25462 RELINGEN BEI HAMBURG, F.R. OF GERMANY
YAMAHA ELECTRONIQUE FRANCE S.A. RUE AMBROISE CROIZAT BP70 CROISSY-BEAUBOURG 77312 MARNE-LA-VALLEE CEDEX02, FRANCE
YAMAHA ELECTRONICS (UK) LTD. YAMAHA HOUSE, 200 RICKMANSWORTH ROAD WATFORD, HERTS WD1 7JS, ENGLAND
YAMAHA SCANDINAVIA A.B. J A WETTERGRENS GATA 1, BOX 30053, 400 43 VÄSTRA FRÖLUNDA, SWEDEN
YAMAHA MUSIC AUSTRALIA PTY, LTD. 17-33 MARKET ST., SOUTH MELBOURNE, 3205 VIC., AUSTRALIA

YAMAHA CORPORATION

VZ85100